

Article number: 23017751118K
 Description: E+G Handwheel
 VR.180 FP-A18-K

Measures

VR.FP-A

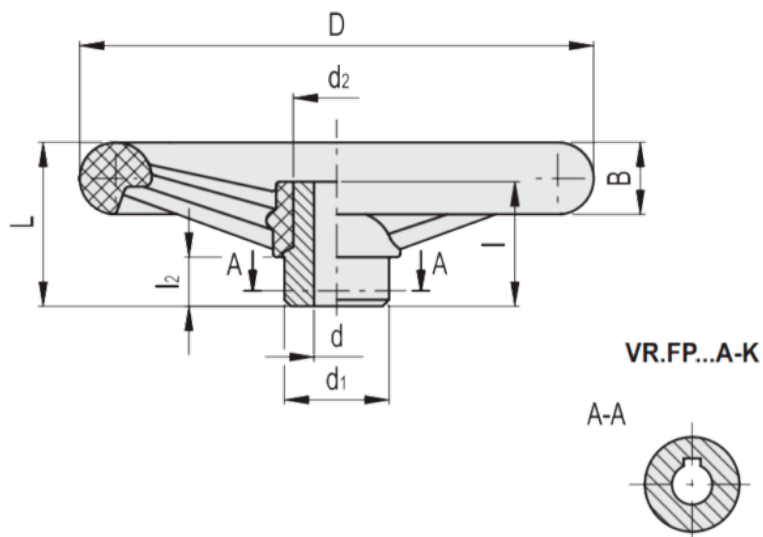

B	= 24	l	= 43
b	= 6	L	= 56
C (N*m)	= 280	L (J)	= 15
D	= 180	l2	= 15
d1	= 40	t	= 20.8
d2	= 31		
d'''	=		
d''''	=		